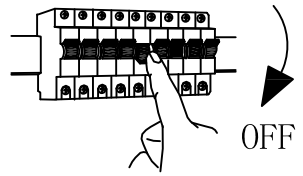
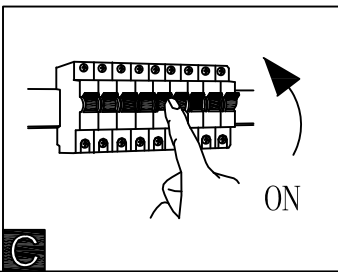
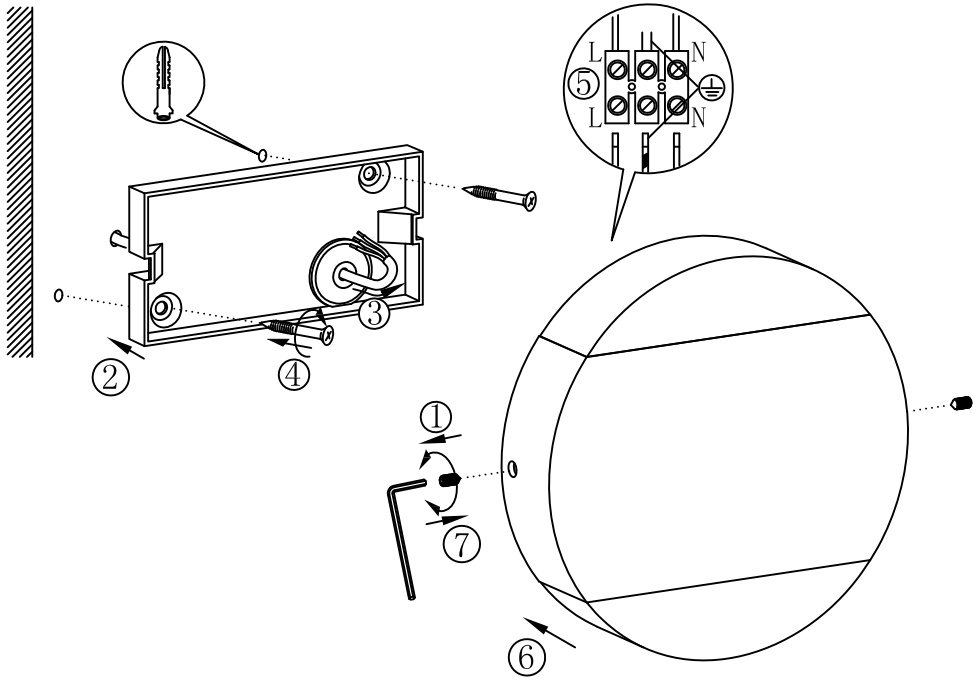

**B****A****C**

BLA75456  
 www.eglo.com