

# GLOBO

## LIGHTING

www.globo-lighting.com

# 58329B

# 58329W

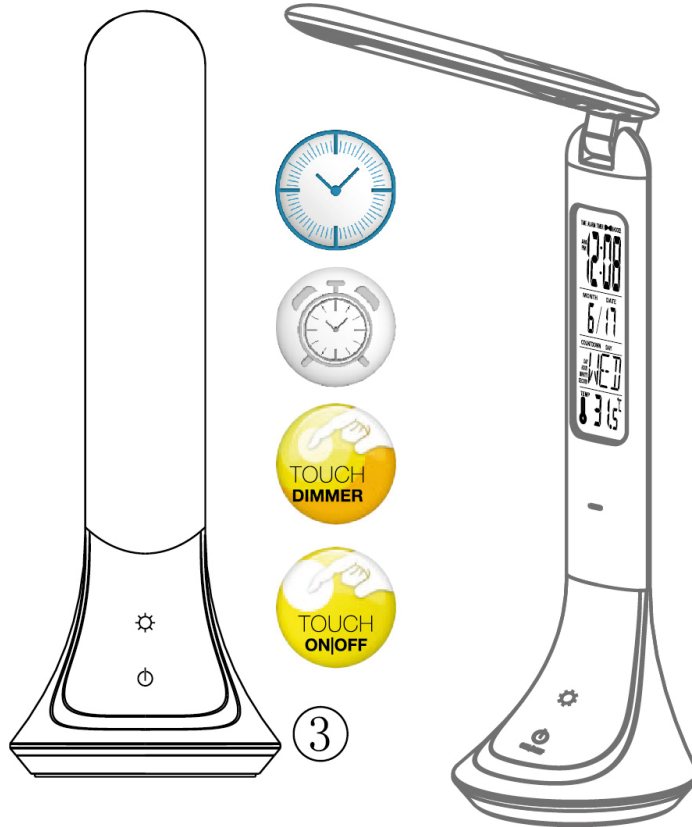
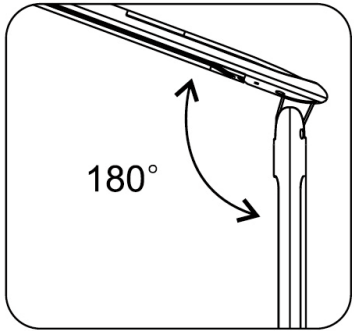

3

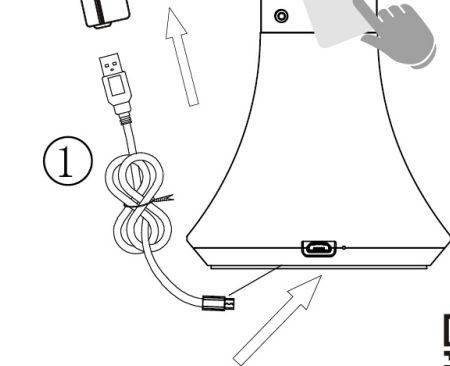
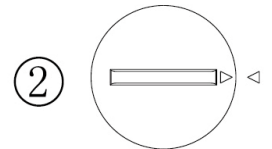
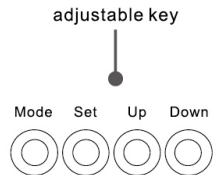
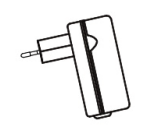
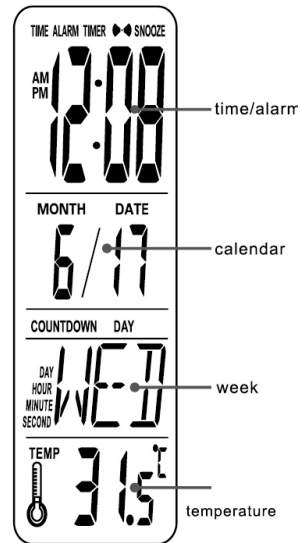

LED back light ON/OFF

